

■ **ELECTRICAL SPECIFICATION**

PARAMETER		VALUE
Frequency Range		19.000 ~ 800.000 MHz
Operating Temperature Range		-20°C ~ +70°C Standard -40°C ~ +85°C Extended
Frequency Stability		±25 ppm, ±50 ppm, ±100ppm
Storage Temperature Range		-55°C to +125°C
Supply Voltage (Vcc)		1.8V, 2.5 V, 3.3 V
Supply Current		80 mA max
Output LVPECL	Symmetry	40% to 60% at 50% Wave form (45% to 55% Available)
	Logic "0" Level	Vcc - 1.620 V max
	Logic "1" Level	Vcc - 1.025 V min
	Load	50 Ω (to Vcc-2 V)
Enable / Disable Function		Pin 1: High or Open / Output enabled (Pins 4 & 5) Pin 1: Low / Output disabled (High impedance)
Rise / Fall Time		1 ns max at 20% ~ 80% Output swing level
RMS Phase Jitter (12kHz ~ 20 MHz)		1 ps max

SERIES CP7050

■ **MECHANICAL SPECIFICATION**

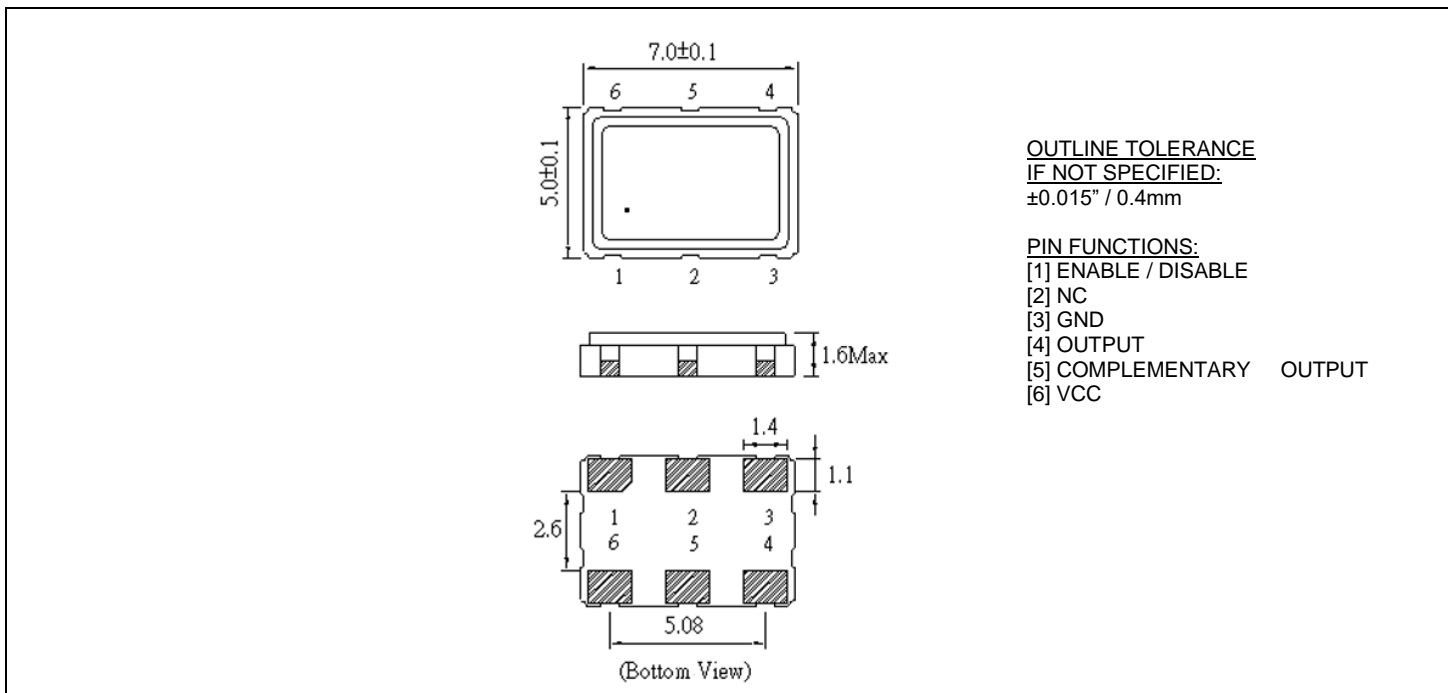

■ **PART NUMBERING SYSTEM**

TYPE	SERIES	FREQUENCY (MHz)	SUPPLY VOLTAGE (Vcc)	STABILITY (ppm)	TEMPERATURE RANGE (°C)	SYMMETRY (Duty Cycle)	TAPE & REEL
Clock Oscillator CP	7050	19.000 ~ 800.000 MHz	1.8: Vcc=1.8 2.5: Vcc=2.5 3.3: Vcc=3.3	25: ±25 ppm 50: ±50 ppm 100: ±100 ppm	blank: -20°C to +70°C X: -40°C to +85°C	blank: 40 to 60% T: 45 to 55%	TR

*Other ranges available. Please contact factory.

EXAMPLE: CP7050-40.000-2.5-25-X-T-TR

Surface Mount CP7050LVPECL Oscillator, 7.0 x 5.0 mm, 40.000 MHz, 2.5 VDC Supply Voltage, ±25 ppm Overall Stability, from -40°C to +85°C, Symmetry 45% to 55%, Tape and Reel packaging.

■ **REFLOW PROFILE**

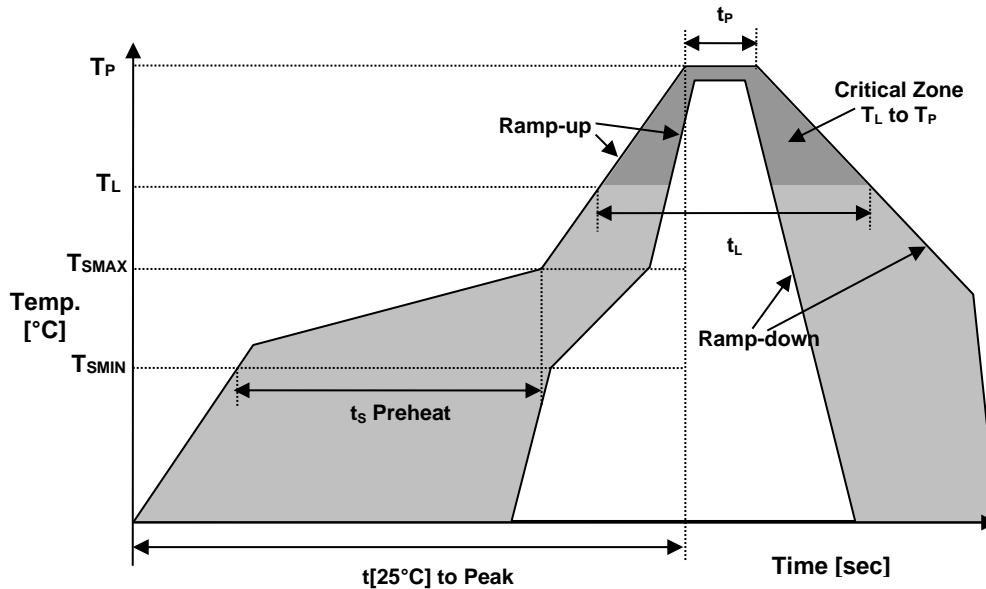

Reflow profile		
Temperature Min Preheat	T_{SMIN}	150°C
Temperature Max Preheat	T_{SMAX}	200°C
Time (T_{SMIN} to T_{SMAX})	t_s	60-180 sec.
Temperature	T_L	217°C
Peak Temperature	T_P	260°C
Ramp-up rate	R_{UP}	3°C/sec max.
Ramp-down rate	R_{DOWN}	6°C/sec max.
Time within 5°C of Peak Temperature	t_p	10 sec.
Time $t[25°C]$ to Peak Temperature	$t[25°C]$ to Peak	480 sec.
Time	t_L	60-150 sec.

■ **ENVIRONMENTAL**

PARAMETER	VALUE
MOISTURE SENSITIVITY LEVEL	1
REACH SVHC	COMPLIANT
RoHS	COMPLIANT
TERMINATION FINISH	Au

