

Frequency Components and Antennas for Smart Home



Jan. 2023

RALTRON

Introduction



Raltron offers the most comprehensive line of frequency management components for Smart Home, from simple tuning fork crystals to high stability temperature compensated crystal oscillators and antennas. These products are designed to satisfy the ultra-low power, small footprint, and low-cost requirements of this growing market.

Smart Home System Architecture

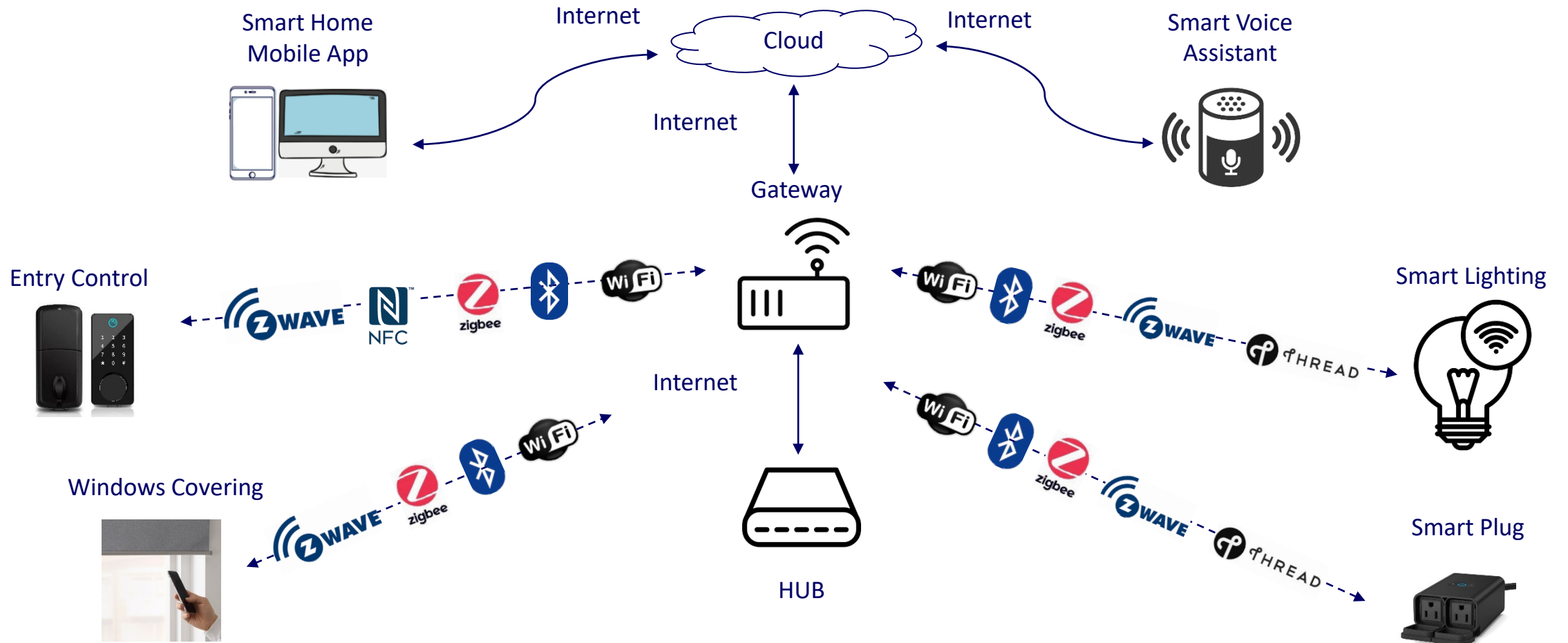

Smart Security System Architecture



Source: <https://www.mymove.com/home-security/home-security-guide/>

Solutions for Bluetooth & BLE Protocol

Bluetooth Low Energy uses the same 2.4 GHz radio frequencies as classic Bluetooth
Some Typical Crystal or TCXO frequencies for [Bluetooth & BLE](#) Smart Home ICs:

Infineon - PSoC 6 MCU: CY8C63x6, CY8C63x7 - 16 MHz/32 MHz Crystal Oscillator
16 to 35 MHz, 32.768 kHz On-chip Crystal Oscillators
- 2.4 GHz Chip Antenna

Nordic Semiconductor - nRF52810 - 64 MHz Crystal Oscillator, 32 MHz Crystal
32.768 kHz Crystal Oscillator, 32.768 kHz Crystal
1 MHz/16 MHz/32 MHz Peripheral Clock
- 2.4 GHz Antenna

Texas Instruments - CC2640R2F - 32.8 kHz/48 MHz RC Oscillator, 24 MHz Crystal Oscillator
32.768 kHz Crystal Oscillator
- 2.4 GHz Antenna

NXP Semiconductors - MKW39/38/37 - 26 MHz/32 MHz Crystal, 32.768 kHz Crystal Oscillator
- 2.4 GHz Antenna

Dialog Semiconductor - DA1469x - 32 MHz Crystal, 32.768 kHz Crystal Oscillator
- 2.4 GHz Antenna

STMicroelectronics - BlueNRG-LPS - 32 MHz Crystal, 32.768 kHz Crystal
- 2.4 GHz Antenna

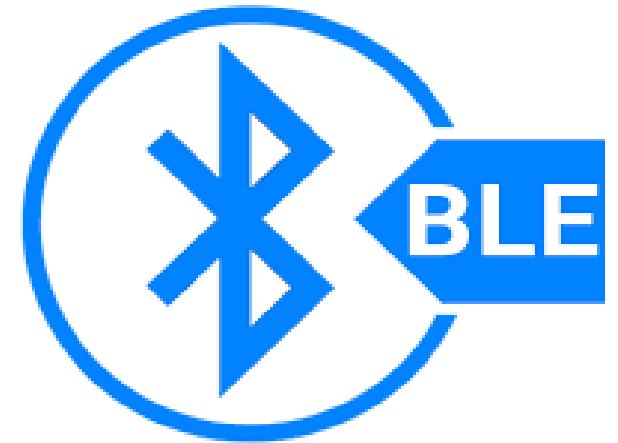

[See All Crystal Products](#)

[See Antenna Products for Bluetooth](#)

Solutions for Wi-Fi Protocol

The Wi-Fi/IEEE 802.11 has three frequency bands, 2.4/5/6 GHz.

Some Typical Crystal or TCXO frequencies for [Wi-Fi](#) Smart Home ICs:

Infineon - CYW43012 - 37.4 MHz, 32.768 kHz
CY8C62xA - 16 to 35 MHz , 32.768 kHz

Silicon Labs - WF200 - 38.4 MHz, 32.768 kHz
RS9116 - 40 MHz, 32.768 kHz

Microchip - ATWINC3400A-MU - 26 MHz, 32.768 kHz



The Wi-Fi 6/IEEE 802.11ax has two frequency bands, 2.4/5 GHz.

The Crystals for lower frequencies of Wi-Fi 6 such as 38.4 and 48 MHz, and for higher are 76.8 and 96 MHz

Some Typical Crystals or TCXO frequencies for [Wi-Fi 6](#) Wireless Smart Home ICs:

SparkLan - WNFB-266AXI(BT) - 37.4 MHz, 32.768 kHz
AP6281 - 59.97 MHz, 32.768 kHz

[See All Crystal Products](#)

[See Antenna Products for Wi-Fi](#)

Solutions for ZigBee Protocol

The ZigBee/IEEE 802.15.4 has three frequency bands, allowing operation in all regions of the world: 2.4 GHz for worldwide applications, 868 MHz for Europe and 915 MHz for the American.

Some Typical Crystal or TCXO frequencies for [ZigBee](#) Smart Home ICs :

Texas Instruments - CC2652RSIP - 48 MHz Crystal
48 MHz Crystal Oscillator
32.768 kHz Crystal Oscillator
- 2.4 GHz Inverted F Antenna

Nordic Semiconductor - nRF52832 - 64 MHz Crystal Oscillator
32 MHz Crystal, 32.768 kHz Crystal Oscillator
1 MHz/16 MHz/32 MHz Peripheral Clock
- 2.4 GHz Chip Antenna

NXP Semiconductors - JN5189 - 32 MHz Crystal Oscillator
32.768 kHz Crystal Oscillator
- 2.4 GHz Antenna

[See All Crystal Products](#)

[See Antenna Products for Zigbee](#)



Solutions for Thread Protocol

Thread uses IEEE 802.15. 4 radio technology on the 2.4 GHz spectrum, which can be deployed worldwide.

Some Typical Crystal or TCXO frequencies for [Thread](#) Smart Home ICs :

Texas Instruments - CC2651R3SIPA - 48 MHz Crystal Oscillator
32.768 kHz Crystal Oscillator
- 2.4 GHz Antenna

Nordic Semiconductor - nRF52840 - 64 MHz Crystal Oscillator
32 MHz Crystal
32.768 kHz Crystal Oscillator
- 2.4 GHz Antenna

Silicon Labs - EFR32MG24 - 39 MHz Crystal Oscillator
32.768 kHz Crystal Oscillator
- 2.4 GHz Antenna

[See All Crystal Products](#)



Solutions for Matter Protocol

Matter is a new smart home standard. It's now maintained by the Connectivity Standards Alliance (CSA), formerly known as the Zigbee Alliance. Matter works over Thread, which is a networking technology that is built on top of 802.15.4. The frequency of Matter is 2.4 GHz.

Some Typical Crystal or TCXO frequencies for [Matter](#) Smart Home ICs :

Qorvo - QPG6105 - 32 MHz Crystal Oscillator
- 2.4 GHz Antenna

NXP Semiconductors - IW416 - 26 MHz Crystal Oscillator
40 MHz Crystal
32.768 kHz Crystal Oscillator
- 2.4 GHz Antenna
5 GHz Antenna

Silicon Labs - EFR32MG24 - 39 MHz Crystal Oscillator
32.768 kHz Crystal Oscillator
- 2.4 GHz Antenna

[See All Crystal Products](#)



Solutions for Z-Wave Protocol

The frequency of Z-Wave is

- 868.40 MHz, 919.80 MHz, 923.90 MHz, 926.30 MHz for Asia
- 868.40 MHz, 869.85 MHz for Europe
- 908.42 MHz, 916.00 MHz for North America

Some Typical Crystal frequencies for [Z-Wave](#) Smart Home ICs :

Silicon Labs - ZM5202AU-CME3R - 32 MHz
ZGM130S - 39 MHz, 32.768 kHz
ZGM230S - 39 MHz
EFR32ZG14 - 39 MHz

ON Semiconductor - AX8052F143-3-TX40 - 16 MHz,
32.768 kHz Tuning Fork,
20 MHz Crystal or TCXO



[See All Crystal Products](#)
[See Antenna Products for Z-Wave](#)

Solutions for Near-field Communication Protocol

NFC operates at 13.56 MHz on ISO/IEC 18000-3 air interface. The technology is a simple extension of the ISO/IEC14443 proximity-card standard(contactless card, RFID).

Some Typical Crystal or TCXO frequencies for [Near-field communication](#) Smart Home ICs:

NXP Semiconductors - PN7160_PN7161 - 27.12 MHz Crystal, 40 MHz Oscillator, 380 kHz Oscillator
PN7150 - 27.12 MHz Crystal, 40 MHz Oscillator, 380 kHz Oscillator
- 1 GHz VCOs

STMicroelectronics - ST25R3916 - 27.12 MHz Crystal, 27 kHz RC Oscillator, 32.768 kHz Crystal
ST25RU3993 - 20 MHz TCXO
ST95HF - 27.12 MHz Crystal
- 1800 MHz VCOs



[See All Crystal Products](#)

Raltron Solutions - Crystals and Oscillators

Available crystal packages

Part #	SIZE(mm)	FREQUENCY(MHz)
RH100-16.000-8.5-1010-EXT-TR	3.20 x 2.50 x 0.70	16
RH100-24.000-7-2020-EXT-TR	3.20 x 2.50 x 0.70	24
R2520-26.000-8-F-1015-EXT-TR-NS 50Ω	2.50 x 2.00 x 0.65	26
RH100-32.000-6-F-2020-EXT-TR-NS 40Ω	3.20 x 2.50 x 0.70	32
R2520-37.400-7.5-F-1010-TR	2.50 x 2.00 x 0.65	37.4
R2520-38.400-10-F-1015-EXT-TR-NS 40Ω	2.50 x 2.00 x 0.65	38.4
R2520-39.000-10-F-2525-EXT-TR-NS 40Ω	2.50 x 2.00 x 0.65	39
RH100-64.000-12-F-3030-EXT-TR-NS 60Ω	3.20 x 2.50 x 0.70	64

Available oscillator packages

Part #	SIZE(mm)	FREQUENCY(MHz)
CO2520-32.000-3.3-20-T-TR	2.50 x 2.00 x 1.00	32
CO2520-48.000-3.3-20-T-TR	2.50 x 2.00 x 1.00	48
CO2520-0.032768-3.3-50-X-T-TR	2.50 x 2.00 x 1.00	0.032768
COM1-0.032768-3.3-50-X-T-TR	3.20 x 2.50 x 1.20	0.032768

R2520 Specifications

PARAMETER	VALUE
FREQUENCY RANGE*	12.00 MHz to 80.00 MHz
MODE OF OSCILLATION	Fundamental
FREQUENCY TOLERANCE AT 25°C	±50 ppm max (±10, ±20, ±30ppm available)
FREQUENCY STABILITY OVER TEMPERATURE*	±50 ppm max (±10, ±20, ±30ppm available)
OPERATING TEMPERATURE RANGE*	-10°C to +60°C Standard ¹ -40°C to +85°C Extended ¹
STORAGE TEMPERATURE RANGE	-40°C to +85°C
AGING	±2 ppm 1st year max
LOAD CAPACITANCE	8 pF to 32 pF or Series
EQUIVALENT SERIES RESISTANCE	See Table 1
SHUNT CAPACITANCE	3.5 pF max
DRIVE LEVEL	100 μW max
SHOCK RESISTANCE	±5 ppm max 75 cm drop test onto a hard wood surface
REFLOW CONDITIONS	260°C for 10s max



Typical Frequencies: [See All Crystal Products](#)

16 MHz, 20 MHz, 24 MHz, 26 MHz, 32 MHz, 26 MHz, 37.4 MHz, 38.4 MHz, 39 MHz, 40 MHz, 48 MHz, 59.97 MHz, 64 MHz

Raltron Solutions - Tuning Fork 32.768 kHz

Raltron is offering 32.768 kHz tuning fork crystals in:

Ceramic Packages:

- 1.2 x 1.0 mm Raltron Tuning Fork Crystal - [RT1210](#)
- 1.6 x 1.0 mm Raltron Tuning Fork Crystal - [RT1610](#)
- 2.0 x 1.2 mm Raltron Tuning Fork Crystal - [RT2012](#)
- 3.2 x 1.5 mm Raltron Tuning Fork Crystal - [RT3215](#)

Plastic Molded Packages:

- 6.9 x 1.4 mm Raltron Tuning Fork Crystal - [RSE H14](#)
- 8.0 x 3.8 mm Raltron Tuning Fork Crystal - [RSM200S](#)

[See All Crystal Products](#)

Load capacitance values: 6 pF, 7 pF, 9 pF and 12.5 pF

Frequency Tolerances: ± 20 ppm and ± 10 ppm

Typical example of IC for Smart Home using a 32.768 kHz crystal as frequency reference:

Texas Instruments - CC1352P7

Using 32.768 kHz crystal

CL: 6, 7 or 12 pF

ESR: 90 k Ω max

RT1210 Specifications

PARAMETER	VALUE
NOMINAL FREQUENCY	32.768 kHz
MODE OF OSCILLATION	Fundamental
FREQUENCY TOLERANCE AT 25°C $\pm 3^\circ\text{C}$	± 20 ppm *
FREQUENCY STABILITY OVER TEMPERATURE COEFFICIENT	-0.036 ppm / $^\circ\text{C}^2$ typ
OPERATING TEMPERATURE RANGE	-40°C to +85°C
STORAGE TEMPERATURE RANGE	-55°C to +125°C
AGING AT 25°C $\pm 3^\circ\text{C}$	± 5 ppm first year max
INSULATION RESISTANCE AT 100 VDC	500 M Ω
LOAD CAPACITANCE	6 pF to 12.5 pF
EQUIVALENT SERIES RESISTANCE	90 k Ω max
SHUNT CAPACITANCE	1.4 pF typ
DRIVE LEVEL	0.3 μw max

Internal Lead Connections

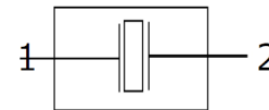

Unit: mm

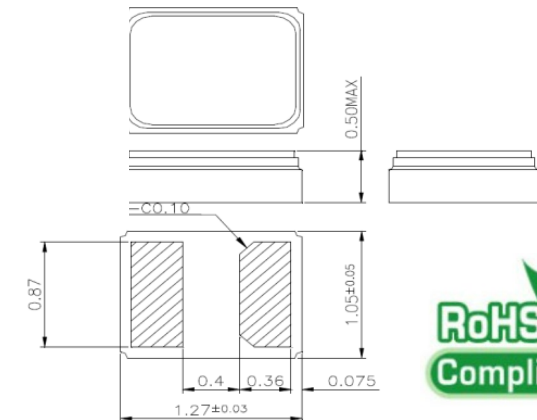

Raltron Solutions - TCXO s and VCTCXOs

Raltron TCXOs IC Solutions

Part #	Size(mm)
RTX-2016AF31-S-16.000-TR	2.0 x 1.6
RTX-2520AF31-S-32.000-TR	2.5 x 2.0
RTX-2520AF31-S-48.000-TR	2.5 x 2.0
RTX-1612AF31-S-48.000-TR	1.6 x 1.2

[See All TCXOs Products](#)

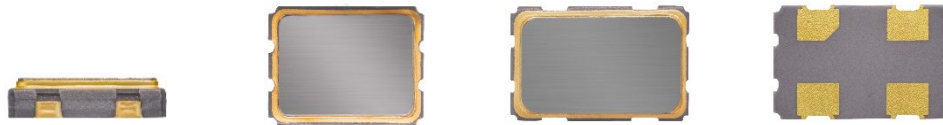

- Tighter Stability: ± 0.5 ppm ~ ± 2.5 ppm, $-40 \sim +85^{\circ}\text{C}$
- Improved Frequency Tuning Characteristic
- Superior Phase Noise Performance (-130 dBc/Hz on the floor)
- Range Supply Voltage: 1.8 V ~ 3.3 V
- Typical Frequencies: 10.0 MHz, 16.0 MHz, 19.2 MHz, 20.0 MHz, 26.0 MHz, 32.0 MHz, 38.4MHz, 48.0 MHz, 50.0 MHz, 52.0 MHz

SERIES RTX/RTV-2016

PARAMETER		VALUE
FREQUENCY RANGE		13 ~ 52 MHz
SUPPLY VOLTAGE		1.8 ~ 3.3 V
INPUT CURRENT		3.0 mA max
FREQUENCY STABILITY	vs. TEMPERATURE	$\pm 0.5 \sim \pm 2.5$ ppm
	vs. LOAD ($\pm 10\%$)	± 0.2 ppm max
	vs. SUPPLY VOLTAGE	± 0.2 ppm max
	AGING 1 st YEAR	± 1.0 ppm max
FREQUENCY TOLERANCE at 25°C AFTER 2 REFLAWS		± 2.5 ppm max
OPERATING TEMPERATURE RANGE ¹		$-40 \sim +85^{\circ}\text{C}$
STORAGE TEMPERATURE RANGE		$-40 \sim +85^{\circ}\text{C}$
CLIPPED SINEWAVE OUTPUT VOLTAGE		0.8 VP-P typ
OUTPUT LOAD		10 k Ω // 10 pF
START-UP TIME		5 ms max
FREQUENCY TUNING RANGE ²		$\pm 7 \sim \pm 16$ ppm
PHASE NOISE at 1 kHz OFFSET		-130 dBc/Hz max

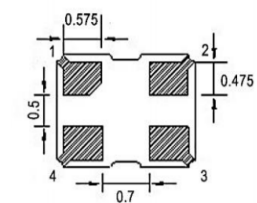
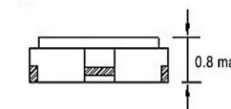
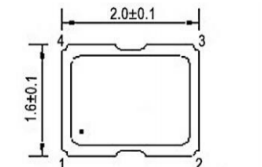

(Bottom View)

OUTLINE TOLERANCE
IF NOT SPECIFIED:
 $\pm 0.015/0.4$ mm

Pin Connections
1 : GND
2 : GND
3 : OUTPUT
4 : V_{cc}

Recommended Solder Pattern

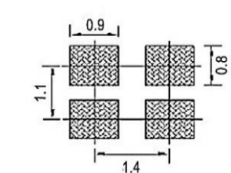

*Add a 1000 pF DC-out capacitor to the output pad of the TCXO



Raltron Solutions – Chip Antennas

Raltron Chip Antennas Solutions

Part #	SIZE(mm)
RCA-W2-P-3216-A36-G	3.20 x 1.60 x 1.20
RCA-6050LO-TR	5.90 x 5.10 x 1.10
RCA-3216-A1-TR	3.20 x 1.60 x 1.20
RCA-S-2012-S1-TR	2.00 x 1.25 x 0.85

[See Antenna Products for Bluetooth](#)

[See Antenna Products for Zigbee](#)

[See Antenna Products for Wi-Fi](#)



RCA-W2-P-3216-A36-G

PARAMETERS	SPECIFICATIONS	UNIT
Center Frequency	2450	MHz
Band Width, typ	100	MHz
Peak Gain	4.97	dBi
Impedance	50	Ω
VSWR, max	2.0	-
Polarization	Linear	-
Azimuth Beam Width	Omni-directional	-
Operating Temperature Range	-40 ~ +85	$^{\circ}\text{C}$
Storage Temperature Range	-40 ~ +85	$^{\circ}\text{C}$

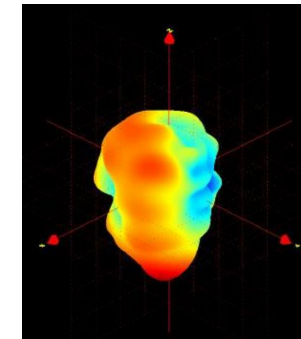

RADIATION PATTERN

PARAMETERS	VALUES			UNIT
Frequency	2400	2450	2500	MHz
Average Gain	-0.75	-0.79	-0.88	dBi
Peak Gain	4.52	4.97	4.85	dBi
Efficiency	70.2	71.1	71.2	%

FREQUENCY CHARACTERISTICS

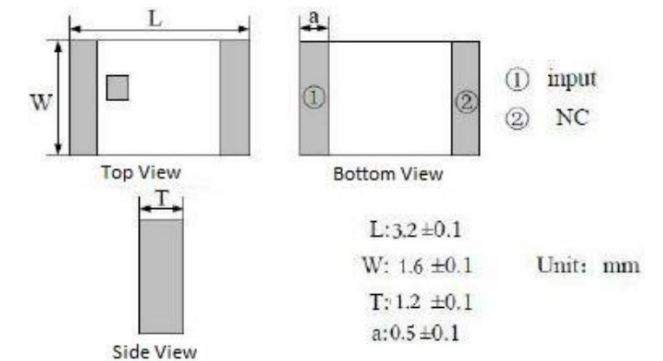
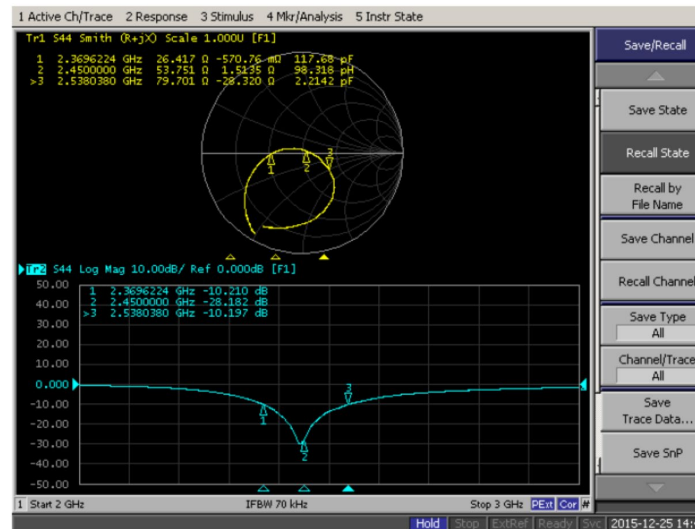

Raltron Products – LTCC Filters, Baluns and Diplexers

Raltron LTCC Filters, Baluns and Diplexers Solutions

Part #	Size(mm)
RCF-5500.000-700000-1005-W-001	1.00 x 0.50
RBL-2430.000-1005-EV-001	1.00 x 0.50 x 0.40
RCDI-24-49-1608-W-TR	1.60 x 0.80 x 0.60
RCDI-W2A1-W5A17-1608-W-TR	1.60 x 0.80 x 0.60

[See All LTCC Filters, Baluns and Diplexers Products](#)

RCDI-W2A1-W5A17-1608-W-TR

PARAMETERS	SPECIFICATIONS		UNIT	
Frequency Range	2400 ~2496	5150 ~ 5950	MHz	
Insertion Loss, max	0.5		1.0	dB
Attenuation, min	35 @ 4800~5000 MHz	30 @ 70~2000 MHz	dB	
	15 @ 7200~7500 MHz	30 @ 2400~2690 MHz	dB	
		12 @ 7250~7800 MHz	dB	
		25 @ 10300~12000 MHz	dB	
	10 @ 15000~18000 MHz	dB		
VSWR, max	1.6		-	
Impedance	50		Ω	
Operating Temperature Range	-40 ~ +85		$^{\circ}$ C	
Moisture Sensitivity Levels	Level 1 (IPC/JEDEC J-STD-020)		-	

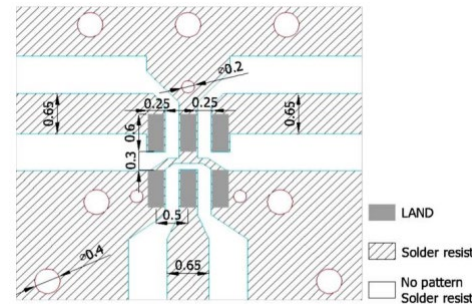
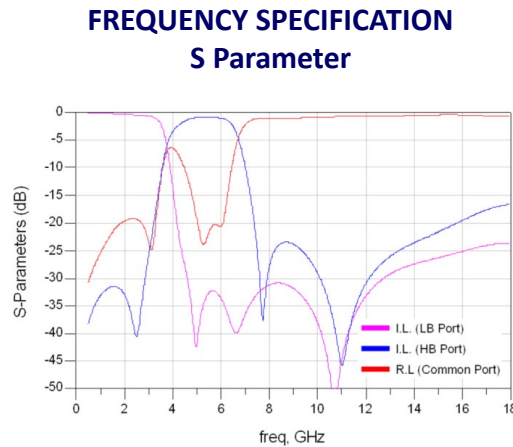

Solder Land Pattern
Unit: mm

Line width to be designed to match 50 Ω characteristic impedance, depending on PCB material and thickness.

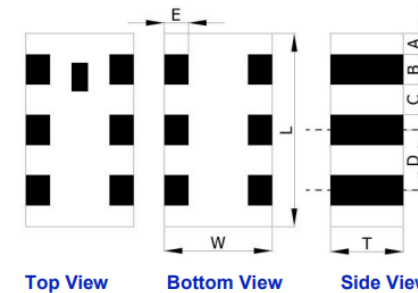

Unit: mm

	L	W	T	A
Dimension	1.60 \pm 0.15	0.80 \pm 0.15	0.60 \pm 0.10	0.175 \pm 0.15
Dimension	B	C	D	E
Dimension	0.25 \pm 0.15	0.25 \pm 0.15	0.50 \pm 0.15	0.20 \pm 0.15



Raltron Solutions – SAW Filters

Raltron SAW Filter IC Solution

Part #	Size(mm)
RSF-916.500-5200-1411-TR-NS3	1.40 x 1.10 x 0.60
RSF-868.300-7000-3030-TR	3.00 x 3.00 x 1.28
RSF-915.000-926000-2016-TR	2.00 x 1.60 x 0.73

[See All SAW Filters Products](#)

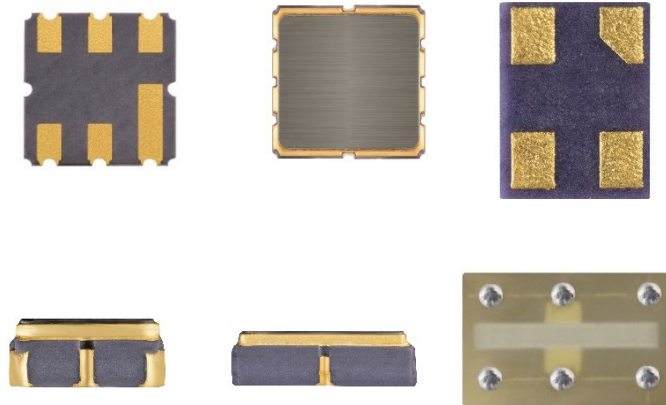

RSF-868.300-7000-3030-TR

Parameters	Value	Unit
Center Frequency (F ₀)	868.300	MHz
Insertion Loss (In F ₀ ± 3.5 MHz), typ/max	2.5 / 3.5	dB
Amplitude Ripple (In F ₀ ± 3.5 MHz), typ/max	1.2 / 2.0	dB
Attenuation min/typ	0.3 ~ F ₀ - 20 MHz	-40 / -50
	F ₀ + 20 ~ 1500 MHz	-40 / -50
In/Out Impedance	50	Ω
Power, max	10	dBm
Operating Temperature Range	-40 ~ +85	°C
Storage Temperature Range	-45 ~ +85	°C

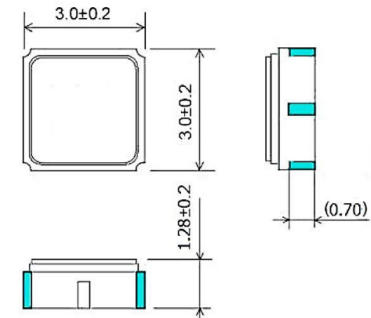
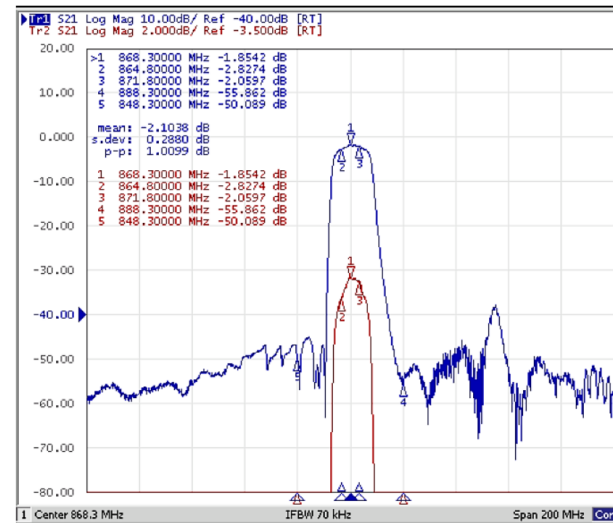

Pin Description	
1,3,4,6	Ground
2	In
5	Out

Raltron Solutions - RF Connectors and RF Cable Assemblies

Raltron RF connectors with low insertion loss and excellent voltage standing wave ratio support the high-level performance demanded by Smart Home.



SMA CONNECTORS - [RCN-1M-21419-K-001](#)

BNC CONNECTORS - [RCN-3F-3108-K-001](#)

MCX CONNECTORS - [RCN-4F-28012-K-001](#)

MMCX CONNECTORS - [RCN-5F-33106-K-001](#)

TNC CONNECTORS - [RCN-9M-16205-K-001](#)

N CONNECTORS - [RCN-17M-12816-K-001](#)

Raltron cable assemblies range from simple jumpers to power and high-speed data cables.

SMA TO IPEX CABLE - RCB-16-F-95-11-SD

MCX TO MCX CABLE - RCB-21-174-150-DO-001

MCX TO SMA CABLE - RCB-14-H-100-12-SD

MMCX TO SMA CABLE - RCB-15-A-100-12-SD

TNC TO SMA CABLE - RCB-13-J-600-13-SD

[CABLE ASSEMBLIES SHORT FORM CATALOG](#)



Contact



<http://www.raltron.com>

Raltron Electronics

10400 N.W. 33rd Street

Miami, FL 33172, U.S.A.

Phone: 305 593 6033

Fax: 305 594 3973